

Line Input Transformer

1:1 FOR 'BALANCED BRIDGING' INPUTS

- Ideal for balancing any high-impedance unbalanced input
- Wide bandwidth: -3 dB at 0.25 Hz and 95 kHz
- Recommended for levels up to +20 dBu at 20 Hz
- High input impedance: 13 kΩ with 10 kΩ load
- High common-mode rejection: 107 dB at 60 Hz

This transformer is designed for use in wideband line input stages. Distortion remains very low and CMRR remains high, even when driven by high source impedances. The primary is fully balanced and its leads may be reversed to invert polarity, if required. A 30 dB magnetic shield package is standard.

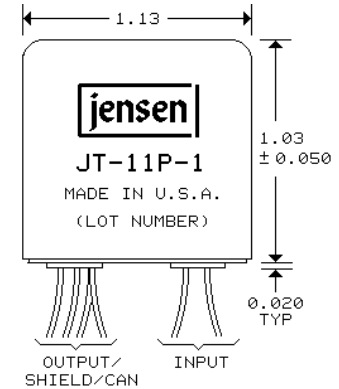

#30 AWG (7x38) UL STYLE 1061 COLOR CODED WIRE LEADS, 8" MINIMUM LENGTH

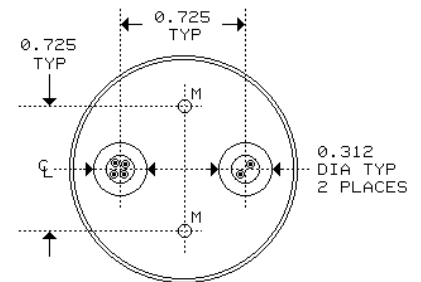
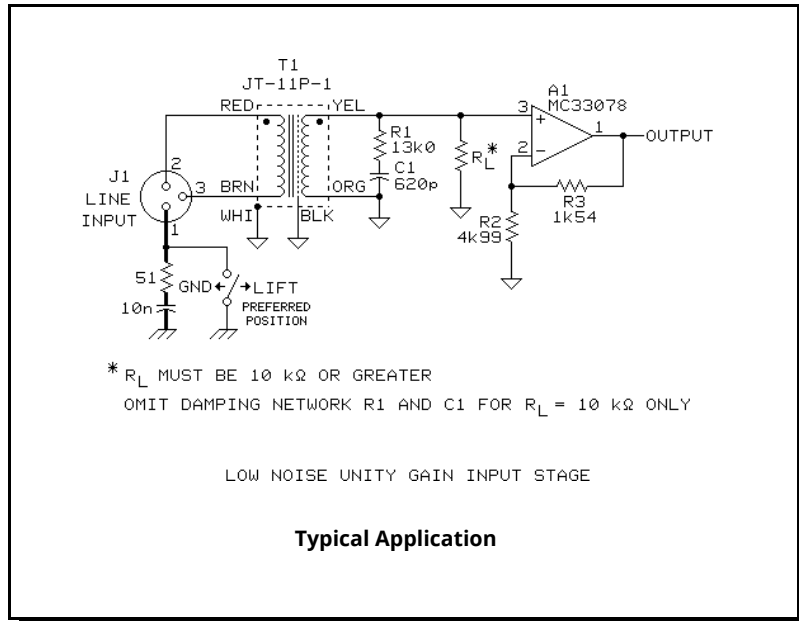

BOTTOM VIEW

USE ONLY #4 TYPE B SELF TAPPING SCREWS IN HOLES "M". ALLOW NO MORE THAN 0.15" PENETRATION INTO TRANSFORMER HOUSING.

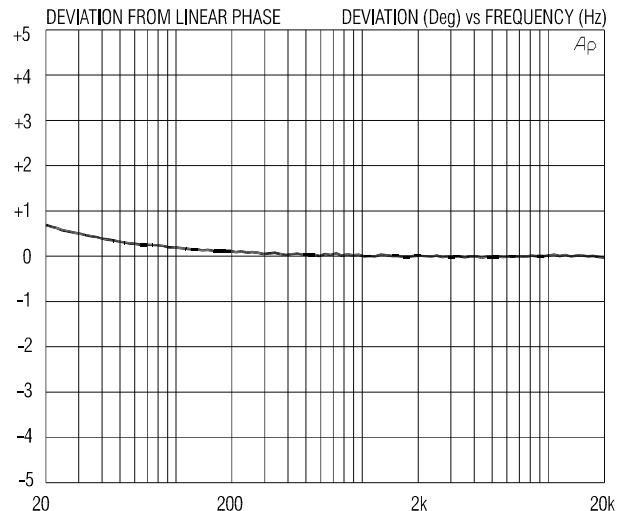
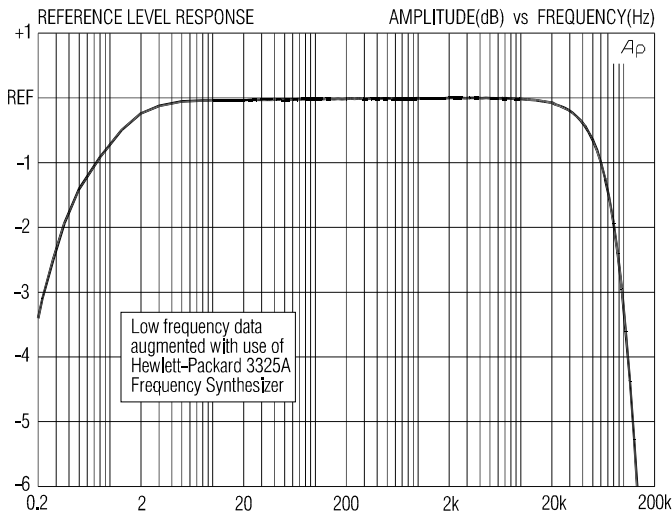

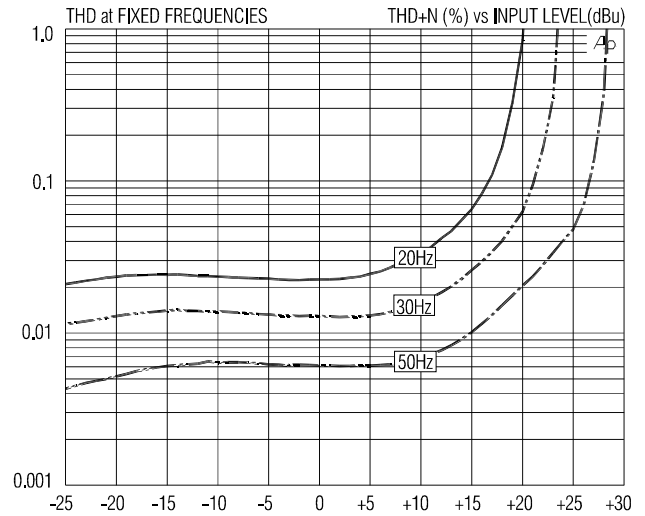
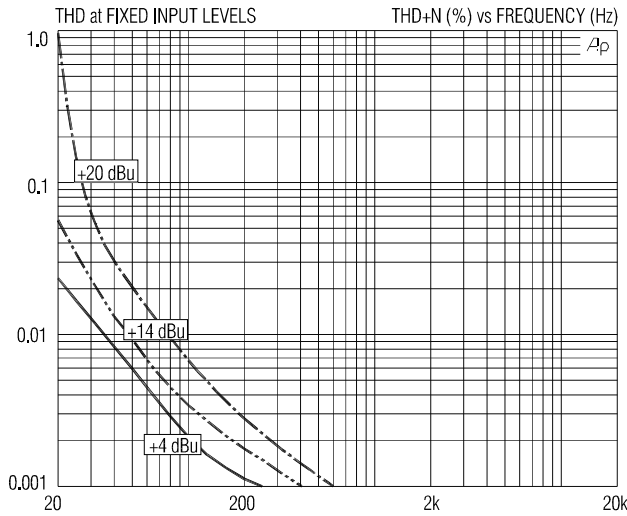

JT-11P-1 SPECIFICATIONS (all levels are input unless noted)

PARAMETER	CONDITIONS	MINIMUM	TYPICAL	MAXIMUM
Input impedance, Zi	1 kHz, +4 dBu, test circuit 1	12.3 kΩ	13.0 kΩ	13.7 kΩ
Voltage gain	1 kHz, +4 dBu, test circuit 1	-2.6 dB	-2.3 dB	-2.0 dB
Magnitude response, ref 1 kHz	20 Hz, +4 dBu, test circuit 1, Rs=600 Ω	-0.15 dB	-0.04 dB	0.0 dB
	20 kHz, +4 dBu, test circuit 1, Rs=600 Ω	-0.15 dB	-0.05 dB	0.0 dB
Deviation from linear phase (DLP)	20 Hz to 20 kHz, +4 dBu, test circuit 1, Rs=600 Ω		+0.6°	±2.0°
Distortion (THD)	1 kHz, +4 dBu, test circuit 1, Rs=600 Ω		<0.001%	
	20 Hz, +4 dBu, test circuit 1, Rs=600 Ω		0.025%	0.10%
Maximum 20 Hz input level	1% THD, test circuit 1, Rs=600 Ω	+18 dBu	+20 dBu	
Common-mode rejection ratio (CMRR) 50 Ω balanced source	60 Hz, test circuit 2		107 dB	
	3 kHz, test circuit 2	65 dB	73 dB	
Common-mode rejection ratio (CMRR) 600 Ω unbalanced source	60 Hz, test circuit 3		100 dB	
	3 kHz, test circuit 3		68 dB	
Output impedance, Zo	1 kHz, test circuit 1, Rs=50 Ω		2.34 kΩ	
DC resistances	primary (RED to BRN)		1.45 kΩ	
	secondary (YEL to ORG)		1.55 kΩ	
Capacitances @ 1 kHz	primary to shield and case		98 pF	
	secondary to shield and case		110 pF	
Turns ratio		0.999:1	1.000:1	1.001:1
Temperature range	operation or storage	0° C		70° C
Breakdown voltage (see IMPORTANT NOTE below)	primary or secondary to shield and case, 60 Hz, 1 minute test duration	250 V RMS		

IMPORTANT NOTE: This device is NOT intended for use in life support systems or any application where its failure could cause injury or death. The breakdown voltage specification is intended to insure integrity of internal insulation systems; continuous operation at these voltages is NOT recommended. Consult our applications engineering department if you have special requirements.

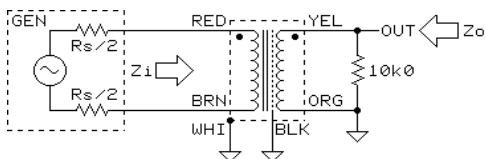

TEST CIRCUIT 1

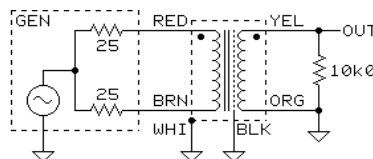

TEST CIRCUIT 2

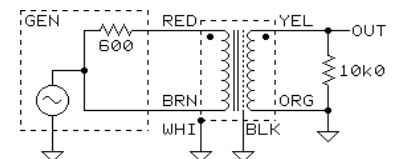

TEST CIRCUIT 3

All minimum and maximum specifications are guaranteed. Unless noted otherwise, all specifications apply at 25°C. Specifications subject to change without notice. All information herein is believed to be accurate and reliable, however no responsibility is assumed for its use nor for any infringements of patents which may result from its use. No license is granted by implication or otherwise under any patent or patent rights of Jensen Transformers, Inc.